



# John Berends Implements Pty Ltd

AGRICULTURAL ENGINEERS

## OPERATOR'S MANUAL PARTS LIST



### Bale/Pallet Handling Linkage Equipment

**PROD NO.**

0285	Round Bale Handler (One large spike, one small spike)
0286	Bale Fork (Two high tensile spikes)
0284	Round Bale Feed Out Fork
0287	Adjustable Round Bale Feed Out Fork
0288	Big Square Bale Handling Fork (Three high tensile spikes)
0289	Silage Fork – 810mm tines
0290	Silage Fork – 980mm tines
0291	Silage Fork – 1100mm tines
0292	Silage Fork – 1250mm tines
0293	Silage Fork – 1400mm tines
0297	Pallet forks

130 FRANKSTON-DANDENONG RD, DANDENONG SOUTH,  
VIC. 3175 AUSTRALIA  
(ABN 79 007 035 369)

PHONE (03) 9791 2494

FAX NO. (03) 9794 5568

[berends@johnberendsimplements.com.au](mailto:berends@johnberendsimplements.com.au)

[www.johnberendsimplements.com.au](http://www.johnberendsimplements.com.au)

# TABLE OF CONTENTS

Page No.

SAFETY INSTRUCTIONS.....	2
INTRODUCTION.....	3
MACHINE SPECIFICATIONS.....	3
SAFETY FEATURES.....	5
ASSEMBLY.....	6
OPERATION.....	6
MAINTENANCE.....	6
SPARE PARTS.....	7





# SAFETY





Farm machinery is dangerous if operated incorrectly so please read this manual in its entirety prior to operating the machine.

 No operator, however experienced in farm machinery operation, should attempt to use any machine they have not been competently trained to use. Your local Department of Agriculture can help you with training, as can most Occupational Health and Safety offices, Agricultural schools and colleges and farm equipment dealerships.

 All instructions relating to tractor safety as per the tractor operators manual should be followed. When making any machine adjustments, stop the tractor engine first and wait for all moving parts to stop. Maintain the tractor to ensure it remains safe to use. Do not operate faulty or damaged equipment.

 Extreme caution should be taken when fitting equipment to the tractor's three point linkage. Avoid standing between the implement and the tractor when coupling machinery.

 All machines should be mounted and retained correctly. All guards must be kept in place and correctly maintained. P.T.O. shafts must be correctly attached and secured to both the tractor and the machine. Decals must be visible and legible at all times. Keep well clear of all moving parts.

 Keep all people and animals at a safe distance from all moving parts. Children must not be allowed to operate this equipment and all passengers must have the same level of protection as the operator.

 Wear protective clothing where appropriate.

 Never operate when tired (not alert) or in poorly lit areas and stay alert for humps and other hidden hazards. Remove all timber, rocks and foreign objects prior to operation.

 Avoid operating the machine in wet conditions.

 Exercise extreme caution when changing direction on hills. Avoid sudden movement, sudden breaking, high speeds, rough terrain and steep slopes.

 If machine starts to vibrate, stop tractor, turn off engine and investigate.

 After striking a foreign object or if there are doubts about the performance of the machine, stop the tractor as described and check if machine is making excessive noise.

 Extreme caution must be taken when working in public areas (roadsides etc). It is recommended that flaps and chains are fitted to slashers when operating in public areas. These are available as optional extras. Rear flaps are compulsory in public areas.

 Watch overhead clearance and beware of underground pipes and cables.

 Where fitted, hydraulic hoses and fittings must be maintained so as to prevent damage.

 Do not modify this equipment in anyway, or use it for any other purpose than it was designed to do.

 Never work under unsupported machines or adjust unsupported machines. Do not enter the danger zone where a load being carried by a machine could fall on you, for example a round bale from a bale fork, a log from a carryall or material from a rear end loader.

These instructions should be used in conjunction with any local regulations regarding safety ie OHS.

**Maintenance is essential for safe operation. Ensure maintenance is carried out regularly by people qualified to do so. This is of particular importance on P.T.O. drive machines where driven parts can fly off at high speed if wearing parts are not properly maintained.**

FAILURE TO FOLLOW THESE INSTRUCTIONS AND PROCEDURES MAY RESULT IN EQUIPMENT MALFUNCTION, OR DAMAGE, SERIOUS INJURY OR EVEN DEATH.

## **INTRODUCTION:**

This manual was developed specifically for the machine you have purchased. The information within is to assist you in preparing, operating and maintaining your machine. Please read and understand the contents of the manual completely before attempting to operate your machine, paying special attention to all safety details. With our policy of continuous improvement, products and specifications may change without notice and without incurring the obligation to install such changes on any unit previously delivered.

## **Bale Handling Equipment**

The round bale handler consists of large high tensile single spike and a smaller spike to stop the bale turning. It is capable of handling around 500kg evenly loaded. The maximum size bale recommended is a 4' x 5' hay bale.

The round bale handling fork has a rectangular headstock with two solid high tensile spikes. It is capable of lifting over 1000kg evenly loaded.

The fixed round bale feed out fork is designed to handle and feed out 4' wide bales with diameters from 4' to 6'. The tines are made from RHS and have pins inserted for rolling the bale out. This fork will lift over 1000kg evenly loaded. The adjustable round bale feed out fork can handle bale widths up to 6' and can be adjusted to suit pallets.

The big square bale handling fork is fitted with three high tensile spikes and is capable of lifting 1500kg evenly loaded.

The silage forks are fitted with high tensile Conus II tines bolted into a tapered sleeve. They are capable of lifting over 1000kg evenly loaded.

## **MACHINE SPECIFICATIONS**

<b>Model</b>	<b>Round Bale Handler</b>	<b>Round Bale Handling Fork</b>	<b>Round Bale Feed Out Fork</b>	<b>Adjustable Round Bale Feed Out Fork</b>	<b>Big Square Bale Handling Fork</b>	<b>Silage Forks</b>	<b>Pallet Forks</b>
No. Spikes/Tines	1	2	2	2	3	2	2
Lifting Capacity (evenly loaded)	500kg	1000kg	1000kg	1000kg	1500kg	1000kg	750kg
Tractor CAT connection	Cat 1/2	Cat 1/2	Cat 1/2	Cat 1/2	Cat 2	Cat 1/2	Cat 1/2
Nett weight (kg)	50	110	110	130	130	100	100

## **WARRANTY**

John Berends Implements P/L warrants each new product sold to be free from defects in material and workmanship, under normal use and service, as outlined in the operators manual, for a period of 12 months.

This warranty is void if any damage to the machine has been caused by misuse or non genuine parts have been used or any repairs have been made by any persons other than authorised dealer service personnel.

The manufacturer/dealer is not obligated to any transportation charges incurred in the repair or replacement of parts.

This warranty does not exclude any condition or warranty implied by the Trade Practices Act 1974 or any other legislation which implies any condition which cannot be excluded.

# Safety Features

## 1. SERIAL NUMBER DECAL



## 2. WARNING DECAL



## 3. BERENDS DECAL

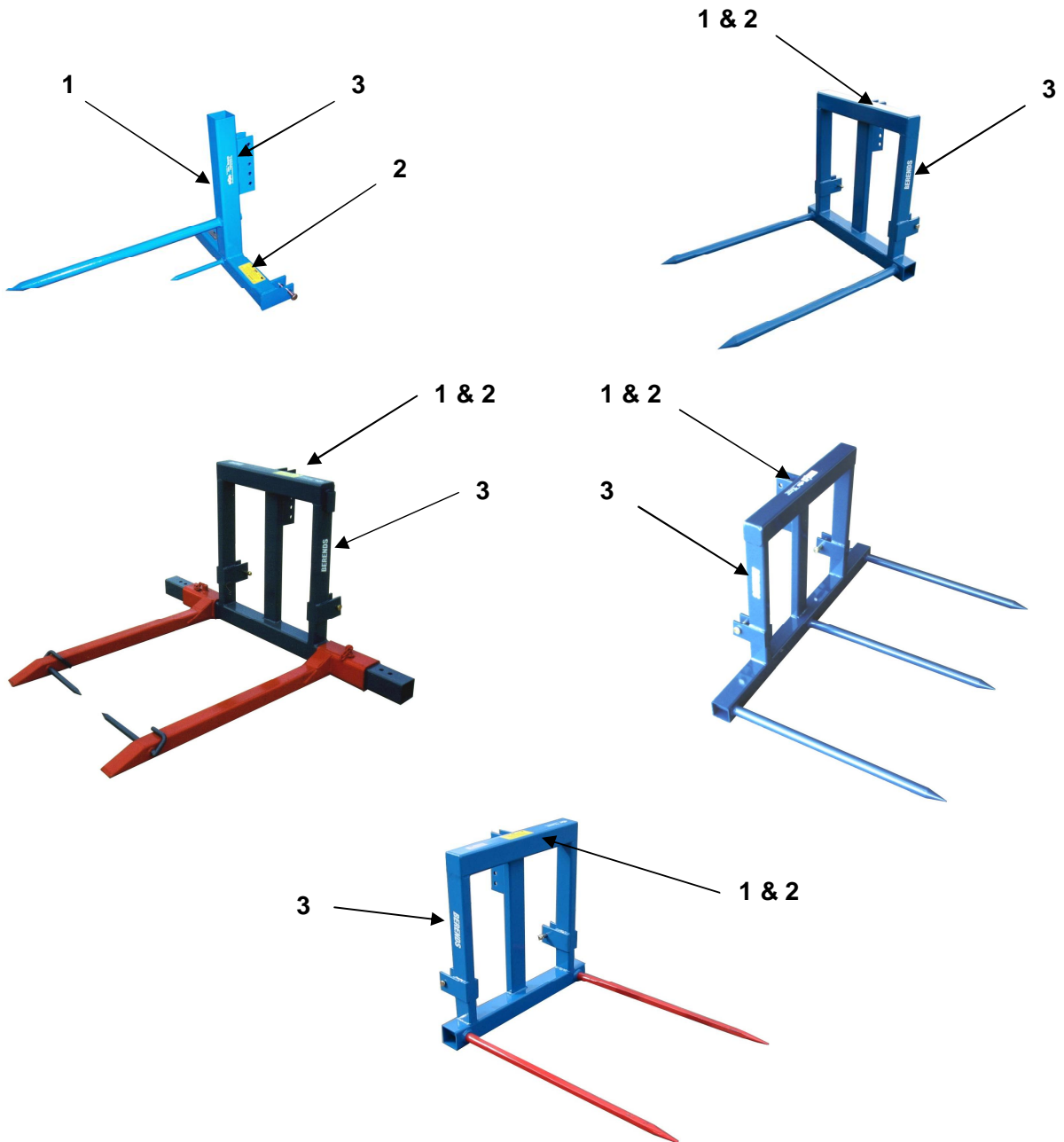

## **ASSEMBLY**

Line the lower linkage arms between the lower linkage plates of the implement, slide the linkage pins through the holes and secure with linch pins. Ensure the lower arms of the tractor have an anti-sway device fitted such as stays or chains. This prevents the implement from swinging side to side during transport. Failure to do so may result in damage not covered by warranty.

Attach the top link to the implement.

(Note: Top link pins and linch pins are not supplied by Berends)

## **OPERATION**

Once all safety procedures have been followed, start the tractor and raise the implement off the ground

Ensure the top link is mounted in the position which provides the best angle for pick-up and transport.

### **Loading**

Weight capacities given in the machine description section at the front of this manual depend on the tractor lift capacity and even loading of the bale/load. Tines often get bent because they get abused. The bale/load must be loaded all the way onto the tines and the operator must ensure that the bale/load does not bounce down to the end of the tine during travel. Do not use the bale handler for any other purpose other than carrying the correct sized bales.

Do not travel too fast whilst the implement is loaded. This can result in the bale bouncing up and down which creates extra force on the tines. This can be minimised by lifting the linkage as high as possible – be careful that the bale doesn't interfere with the tractor cab or ROPS frame when lifted.

**The tensile strength of the tines ensures that each machine is capable of lifting the recommended maximum working load when operated correctly. Any damage to tines is a result of misuse and is subsequently void of warranty.**

When spiking or lifting bales, keep the tines horizontal on entry. This can be achieved by adjusting the top link of the tractor.

### **Stopping**

Lower the implement, stop the tractor engine (removing the ignition key) and apply the park brake. Ensure that the implement is well supported when not in use.

## **MAINTENANCE**

When doing any type of maintenance on this machine, always follow the safety steps described in this manual. Use only authorised genuine parts for replacement. The implement must be adequately supported under its body (Make certain it cannot fall). There is little maintenance on bale handling gear, however, it is advised that periodic checks be made on the frame and tines to ensure that no stress fractures have occurred due to incorrect operation.

# SPARE PARTS

ORDER SPARE PARTS THROUGH YOUR ORIGINAL SUPPLIER OR YOUR LOCAL JOHN BERENDS IMPLEMENTS DEALER.

Always quote the machine serial number or product number, spare part number and its part name as stated in the operator's manual.

## Bale handler (0285)

Key No.	Part No.	Quantity	Description
1	1949	1	Bale spike - short (350mm) weld in
2	1950	1	Bale spike - long (1200mm) weld in
3	1969	2	Cat 1 push through pin

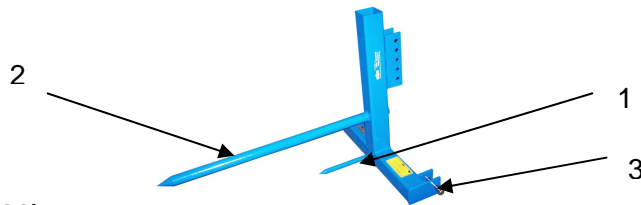

## Bale fork (0286)

Key No.	Part No.	Quantity	Description
1	1950	2	Bale spike - long (1200mm) weld in
2	1969	2	Cat 1 push through pin

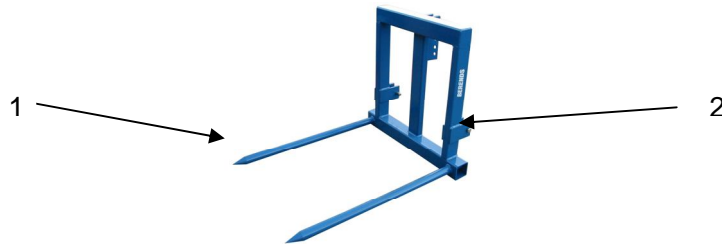

## Fixed Feed Out Fork (0284) and Adjustable Feed Out Fork (0287)

Key No.	Part No.	Quantity	Description
1	3841	1	Complete tine (L/H) – adjustable models only
2	3842	1	Complete tine (R/H) – adjustable models only
3	3330	1	Feedout pin L/H
4	3331	1	Feedout pin R/H
5	1969	2	Cat 1 push through pin

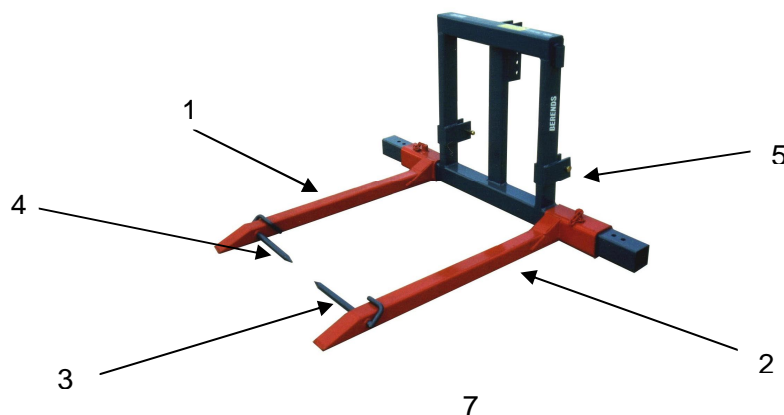



### Big square bale handling fork (0288)

Key No.	Part No.	Quantity	Description
1	1950	3	Bale spike - long (1200mm) weld in
2	1972	2	Cat 2 push through pin

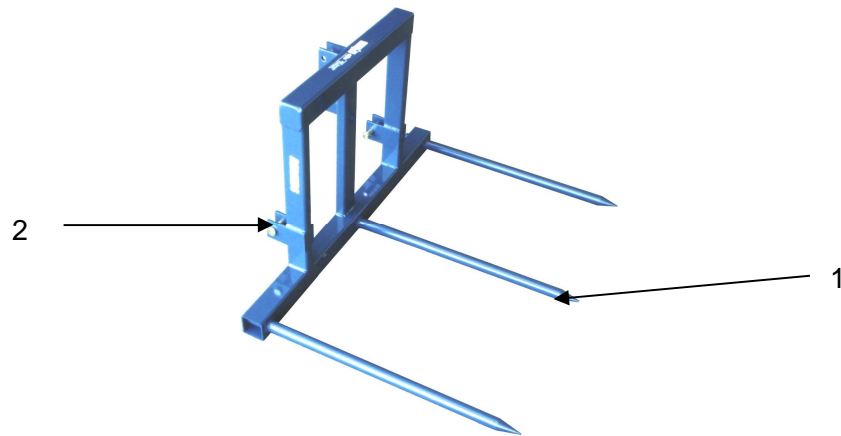

### Silage fork (0289-0293)

Key No.	Part No.	Quantity	Description
1	3855	1	Silage tine frame only (with weld in sleeves)
2	3856	2	810mm tine/nut
	3857	2	980mm tine/nut
	3858	2	1100mm tine/nut
	3859	2	1250mm tine/nut
	3860	2	1400mm tine/nut
3	3861	2	Conus 2 sleeves (weld in )
4	1969	2	Cat 1 push through pin

